

A highly sensitive nonenzymatic glucose sensor based on multi-walled carbon nanotubes decorated with nickel and copper nanoparticles

Kuo-Chiang Lin, Yu-Ching Lin, Shen-Ming Chen*

Electroanalysis and Bioelectrochemistry Lab, Department of Chemical Engineering and Biotechnology, National Taipei University of Technology, No. 1, Section 3, Chung-Hsiao East Road, Taipei 106, Taiwan

ARTICLE INFO

Article history:

Received 27 November 2012
Received in revised form 20 February 2013
Accepted 20 February 2013
Available online xxx

Keywords:

Glucose sensor
Copper
Nickel
Nanoparticles
Carbon nanotubes

ABSTRACT

Novel nickel and copper nanoparticles decorated multi-walled carbon nanotubes (Ni/Cu/MWCNT) have been successfully fabricated for sensitive nonenzymatic glucose detection by the sequential electro-deposition of nickel and copper nanoparticles (NPs) on an MWCNT-modified electrode. X-ray diffraction (XRD) and atomic force microscopy (AFM) analyses reveal that the Ni and Cu NPs were successfully deposited on the MWCNTs in this hybrid composite. The electrode shows good activity towards glucose oxidation with low over-potential and a current response that is 2.5–20 times greater than that obtained using Ni/GCE, Cu/GCE, Ni/Cu/GCE, Ni/MWCNT/GCE, and Cu/MWCNT/GCE. The optimised conditions based on current response are a Ni:Cu ratio of 1:1 and pH 13. Amperometry ($E_{app.} = +0.575$ V) indicates a short response time of 1 s; two specific linear ranges of 2.5×10^{-8} – 8×10^{-4} M and 2×10^{-3} – 8×10^{-3} M, with high sensitivities of $2633 \mu\text{A mM}^{-1} \text{cm}^{-2}$ and $2437 \mu\text{A mM}^{-1} \text{cm}^{-2}$, respectively; and a low detection limit of 2.5×10^{-8} M ($S/N=3$). This electrode can effectively analyse glucose concentration in human serum samples, avoiding interference, and is a promising nonenzymatic glucose sensor due to its low overpotential, high sensitivity, good selectivity, good stability, fast response, and low cost.

© 2013 Elsevier Ltd. All rights reserved.

1. Introduction

For diabetic patients, regular measurements of blood glucose levels are required to determine whether the treatments are working effectively [1]. Enzyme-modified electrodes have some disadvantages, such as instability, the high cost of enzymes, complicated immobilisation procedures, and critical operating conditions. Therefore, considerable attention had been paid to developing nonenzymatic electrodes to overcome these problems. As a result, there is an ever-growing demand to create electrochemical glucose sensors with high sensitivity, high reliability, short response times, good recyclability, and low cost, especially nonenzymatic amperometric biosensors [2], which are currently the most popular.

The direct electrocatalytic oxidation of glucose at a nonenzymatic electrode would have advantages over enzymatic electrodes. Recently, efforts to develop a practical nonenzymatic glucose sensor have been centred on achieving a breakthrough in electrocatalysis. In this context, different substrates, such as platinum [3], gold [4], copper [5], alloys (containing Pt, Pb, Au, Pd, Ir, and Ru) [6–9], and metal oxidates (IrO_2 , MnO_2 , and CuO) [10–12], have been studied. The most important finding in this area to date is that the

highly active surface area of the electrode material plays a key role in the electrooxidation of glucose.

During recent years, nanomaterials, such as carbon nanotubes (CNTs) and transition metallic nanoparticles (NPs), have been widely applied in sensors and biosensors. CNTs are an attractive material for electroanalysis due to their high surface/volume ratio and chemical stability [13–16]. Transition metallic NPs, including gold (Au), platinum (Pt), palladium (Pd), copper (Cu), nickel (Ni), and silver (Ag), can be used to increase electrochemical activities. Sensors and biosensors modified with metallic NPs have demonstrated good performances due to their increased surface area and enhanced mass transport and catalysis as well as good biocompatibility, with control over the microenvironment, relative to macroelectrodes [16–18]. Therefore, their use has been an important strategy in the construction of glucose nonenzymatic sensors with nanomaterials, such as nanoporous Pt electrodes [19,20] and electrodes modified with CNTs [21,22], Ni NPs [23], Au NPs [24,25], Cu NPs [26,27], and CNTs with Cu NPs [28,29]. High sensitivity and fast amperometric detection of glucose had been reported using the methods mentioned above due to an increase in the electrocatalytic active area and the promotion of electron transfer in glucose oxidation reactions.

However, pure metal NPs (such as Ni NPs and pure Cu NPs) are difficult to prepare and have poor stability for electroanalysis due to their ready oxidation in air and solution [18]. The reported methods for the synthesis of colloidal Cu NPs, such as the use of reverse

* Corresponding author. Tel.: +886 2 27017147; fax: +886 2 27025238.
E-mail address: smchen78@ms15.hinet.net (S.-M. Chen).

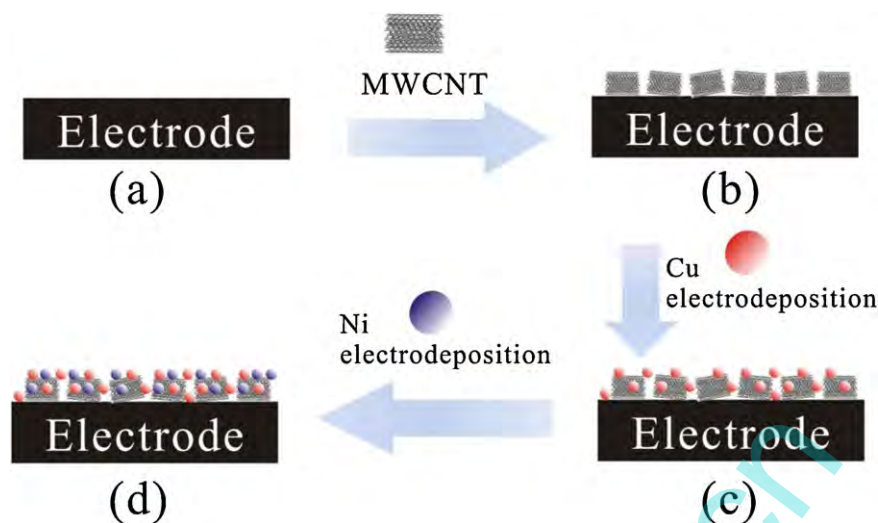

Scheme 1. Preparation of Ni/Cu/MWCNT hybrid composite modified electrode: (a) bare, (b) MWCNT, (c) Cu/MWCNT, and (d) Ni/Cu/MWCNT modified electrodes.

micelles, microemulsions, and radiation techniques, are complex and involve multiple solvent systems [18,28].

In the present study, an effective nonenzymatic sensor, namely, an MWCNT-modified electrode decorated with Ni and Cu NPs was introduced for the catalytic oxidation of glucose. Nickel and copper NPs were sequentially deposited on an MWCNT-modified electrode using a simple electrochemical method. All MWCNTs were functionalised with carboxylic groups [30] to improve their dispersion and immobilisation on the electrode surface. The MWCNTs were drop-casted to form MWCNT-modified electrodes before the electro-deposition of Ni and Cu. The negative charge of the MWCNT attracts the positively charged Ni and Cu ions, which deposit on the MWCNT to form a Ni/Cu/MWCNT hybrid composite. This hybrid composite was characterised by XRD and AFM and applied to investigate the electrocatalytic oxidation of glucose at different pH and compare it with that of other modified electrodes, including Ni/GCE, Cu/GCE, Ni/Cu/GCE, Ni/MWCNT/GCE, Cu/MWCNT/GCE, and Ni/Cu/MWCNT/GCE. It was also used to analyse the glucose concentration in real human blood serum samples. Its performance as a sensor was studied and compared with other nonenzymatic glucose sensors in the literature in terms of sensitivity, selectivity, stability, current response, and reproducibility.

2. Experimental

2.1. Reagents

D-(+)-glucose, dopamine (DA), L-ascorbic acid (AA), uric acid (UA), D-fructose, lactose sucrose, and multi-walled carbon nanotubes (MWCNTs) were purchased from Sigma–Aldrich (USA) and used as received. All other chemicals (Merck) used were of analytical grade (99%). Double-distilled deionised water ($>18.1 \text{ M}\Omega \text{ cm}^{-1}$) was used to prepare all solutions. All other reagents were of analytical grade and used without further purification. The electrochemical measurements were performed in 0.1 M NaOH solution.

2.2. Apparatus and measurements

The Ni/Cu/MWCNT hybrid composite was characterised by atomic force microscopy (AFM) and X-ray diffraction (XRD). The electrochemical experiments were conducted using a CHI 1205a electrochemical workstation (CH Instruments, USA) with a conventional three-electrode setup using the Ni/Cu/MWCNT/GCE as the

working electrode, an Ag/AgCl (3 M KCl) reference electrode, and a platinum wire counter electrode. A BAS (Bioanalytical Systems, Inc., USA) glassy carbon electrode (GCE) with a diameter of 0.3 cm was used for all electrochemical experiments except the amperometric experiment, which used a GCE electrode with a diameter of 0.6 cm. All potentials reported in this paper were referred to a Ag/AgCl electrode. The buffer solution was completely deaerated using a nitrogen gas atmosphere. The electrochemical cells were kept properly sealed to avoid interference with oxygen from the atmosphere. The composite was analysed by XRD, and its morphology was characterised by AFM using a tapping-mode scanning probe microscope (Being Nano-Instruments CSPM-4000, China). Indium tin oxide (ITO) was used as the substrate for various films in the AFM and XRD analyses.

2.3. Preparation of the Ni, Cu, Ni/Cu, Ni/MWCNT, Cu/MWCNT, and Ni/Cu/MWCNT modified electrodes

GCE and ITO substrates were coated with different composites, including Ni, Cu, Ni/Cu, Ni/MWCNT, Cu/MWCNT, and Ni/Cu/MWCNT.

Using a previously published method [31], the Ni electro-deposition was easily carried out in a tetraborate solution (pH 9) containing 0.05 M nickel chloride by consecutive cyclic voltammetry in the potential range of 0.5–1.1 V with a scan rate of 0.1 V s^{-1} and 30 scan cycles. This method was used to prepare Ni, Ni/Cu, Ni/MWCNT, and Ni/Cu/MWCNT modified electrodes.

Using another previously published method [32,33], the Cu electro-deposition was easily carried out in sulphuric solution (pH 1.5) containing 0.025 M copper sulphate by consecutive cyclic voltammetry in the potential range of 0.5 to -0.6 V with a scan rate of 0.1 V s^{-1} and 30 scan cycles. This method was used to prepare Cu, Ni/Cu, Cu/MWCNT, and Ni/Cu/MWCNT modified electrodes.

Prior to the preparation of MWCNT-modified electrodes, all MWCNTs were functionalised with carboxylic groups to confer good dispersion in the prepared solution [30]. This MWCNT solution was drop-casted on the electrode surface to form an MWCNT-modified electrode. Based on our estimation, $2 \mu\text{L}$ and $8 \mu\text{L}$ of the MWCNT solution were dropped on GCEs with diameters of 0.3 cm and 0.6 cm, respectively. Ultimately, $10 \mu\text{L}$ of the MWCNT solution was used in this work to ensure coverage of the entire electrode surface. Next, the effluent from the effective surface area was carefully removed. The electrodes were cleaned

and dried in an oven at 40 °C. The MWCNT-modified electrodes (MWCNT/GCE and MWCNT/ITO) were easily prepared using this method. Metal-MWCNT films were successfully formed based on the preparation of related composites [30–33]. Using the concept illustrated in Scheme 1 [33], Ni and Cu NPs can be sequentially deposited on MWCNT.

The relative amounts of Cu and Ni electro-deposited in the Ni/Cu/MWCNT hybrid composite were set by varying the scan segment. These composites' electrocatalytic activities towards glucose oxidation were analysed as a function of the Cu:Ni ratio. The optimal Cu:Ni ratio and pH conditions were also determined. All modified electrodes, namely, the Ni, Cu, Ni/Cu, Ni/MWCNT, Cu/MWCNT, and Ni/Cu/MWCNT electrodes, were stored at room temperature before use.

3. Results and discussion

3.1. Characterisation of the Ni/Cu/MWCNT nanocomposite

A simple electrochemical synthesis of Ni/Cu/MWCNT hybrid composite was presented in this work. This hybrid composite can be easily prepared by the electrochemical reduction of Ni ions and Cu ions using an MWCNT-modified electrode with suitable potential control. To verify the identity of the product, the composite was prepared on an ITO surface and examined by XRD.

Fig. 1 shows the XRD patterns for (A) Ni/Cu/MWCNT/ITO, (B) Ni/MWCNT/ITO, (C) Cu/MWCNT/ITO, (D) MWCNT/ITO, and (E) ITO. These composites can be clearly identified using the standard patterns (Fig. 1F–H) for Cu, Ni, and ITO, respectively. When the MWCNT was immobilised on ITO, it exhibited patterns (Fig. 1D) almost identical to those of ITO (Fig. 1E). When Cu was further electrodeposited on the MWCNT/ITO to form Cu/MWCNT/ITO (Fig. 1C), three characteristic peaks were observed for Cu at $2\theta = 43.4^\circ$, 50.4° , and 74.2° , corresponding to Miller indices (1 1 1), (2 0 0), and (2 2 0), respectively. The peak positions were in good agreement with the literature values for face-centred cubic Cu [27,34]. This result proves that the resultant particles are pure Cu NPs. For the Ni/MWCNT/ITO electrodes, three characteristic peaks were found at 44.5° , 51.8° , and 76.5° (Fig. 1B), indicating that Ni also has a face-centred cubic structure in the borate bath. The nickel deposit exhibits a (1 1 1) growth orientation with (2 0 0) and (2 2 0) reflections assigned [35,36] as well. The proposed composite exhibited patterns (Fig. 1A) corresponding to Ni, Cu, and ITO. One can conclude that Ni and Cu NPs can be immobilised on the MWCNT well to form a Ni/Cu/MWCNT modified electrode.

The morphology of the different composites was studied by AFM. Fig. 2 shows the AFM images of different metal species deposited on electrode surfaces with/without MWCNTs. The particle sizes for single and multi-composites were estimated and compared with those for the deposited material on the same scale. The average particle sizes were 80.69 nm, 162.78 nm, 53.96 nm, 80.33 nm, 94.53 nm, and 73.2 nm for Ni, Cu, Ni/Cu, Ni/MWCNT, Cu/MWCNT, and Ni/Cu/MWCNT, respectively. Based on this comparison, both Ni and Cu particles are smaller when deposited on an MWCNT electrode. The local particle sizes of Ni and Cu in the Ni/Cu/MWCNT hybrid composite were also measured using the AFM images of the Ni/MWCNT, Cu/MWCNT, and Ni/Cu/MWCNT samples. The smallest particles, corresponding to Ni, have a diameter of 6.9 nm, and the largest, corresponding to Cu, have a diameter of 477 nm. We believe that Cu had more space to deposit on both the MWCNT and the electrode surface because its deposition occurred before the Ni deposition. Consequently, larger Cu clusters are found in the Ni/Cu/MWCNT composite. These findings indicate that Ni and Cu can be sequentially deposited on MWCNT-modified electrodes.

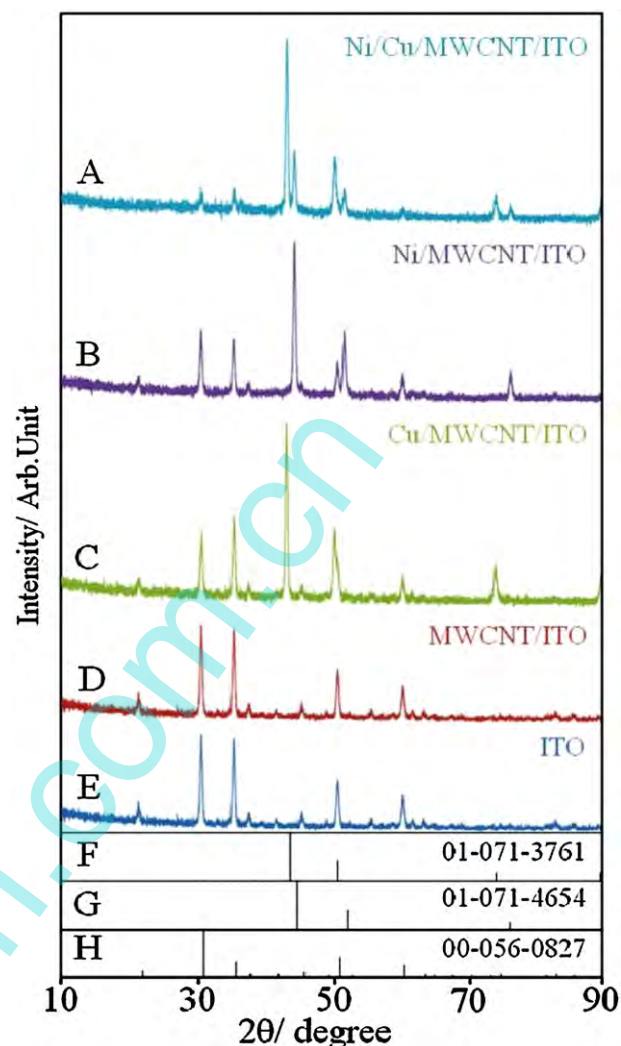

Fig. 1. X-ray diffraction patterns of (A) Ni/Cu/MWCNT/ITO, (B) Ni/MWCNT/ITO, (C) Cu/MWCNT/ITO, (D) MWCNT/ITO, and (E) ITO. (F)–(H) are standard patterns (01-071-3761, 01-071-4654, 00-056-0827) for Ni, Cu, and ITO, respectively.

Based on the XRD results, Cu and Ni are separate particles in the Ni/Cu/MWCNT hybrid composite. From the AFM images, both Ni/Cu and Ni/Cu/MWCNT hybrid composites contain smaller particles than Ni, Cu, Ni/MWCNT, and Cu/MWCNT. Referring to previous results [31,32], this phenomenon might indicate that a more compact structure is formed in both Ni/Cu and Ni/Cu/MWCNT hybrid composites, as shown in Scheme 1. It also indicates that the MWCNT-modified electrode incorporates greater amounts of Ni and Cu by creating a more compact structure, providing more space. One can conclude that the steric structure and large surface area of the MWCNTs facilitate the deposition of Ni and Cu NPs in a more compact structure on the nanoscale.

Fig. 3A shows the voltammograms of Ni/Cu/MWCNT/GCE examined in 0.1 M NaOH (pH 13) at a scan rate (ν) in the range of 10–1000 mV s^{-1} . Both anodic and cathodic peak currents are directly proportional to the scan rate (inset of Fig. 3A) via the linear regression equation of $I_{pa}(\mu\text{A}) = -41.94 + 0.48\nu$ (mV s^{-1}) ($R^2 = 0.9841$) and $I_{pc}(\mu\text{A}) = 5.87 + 0.289\nu$ (mV s^{-1}) ($R^2 = 0.9977$), respectively. These results indicate that the electrochemical kinetics are surface-controlled rather than diffusion-controlled at these scan rates, suggesting an ideal case for quantitative analysis in practical applications. Meanwhile, the cathodic and anodic peaks shifted away from one another, leading to better peak-to-peak separation, as the scan rate increased. These results might be due to the

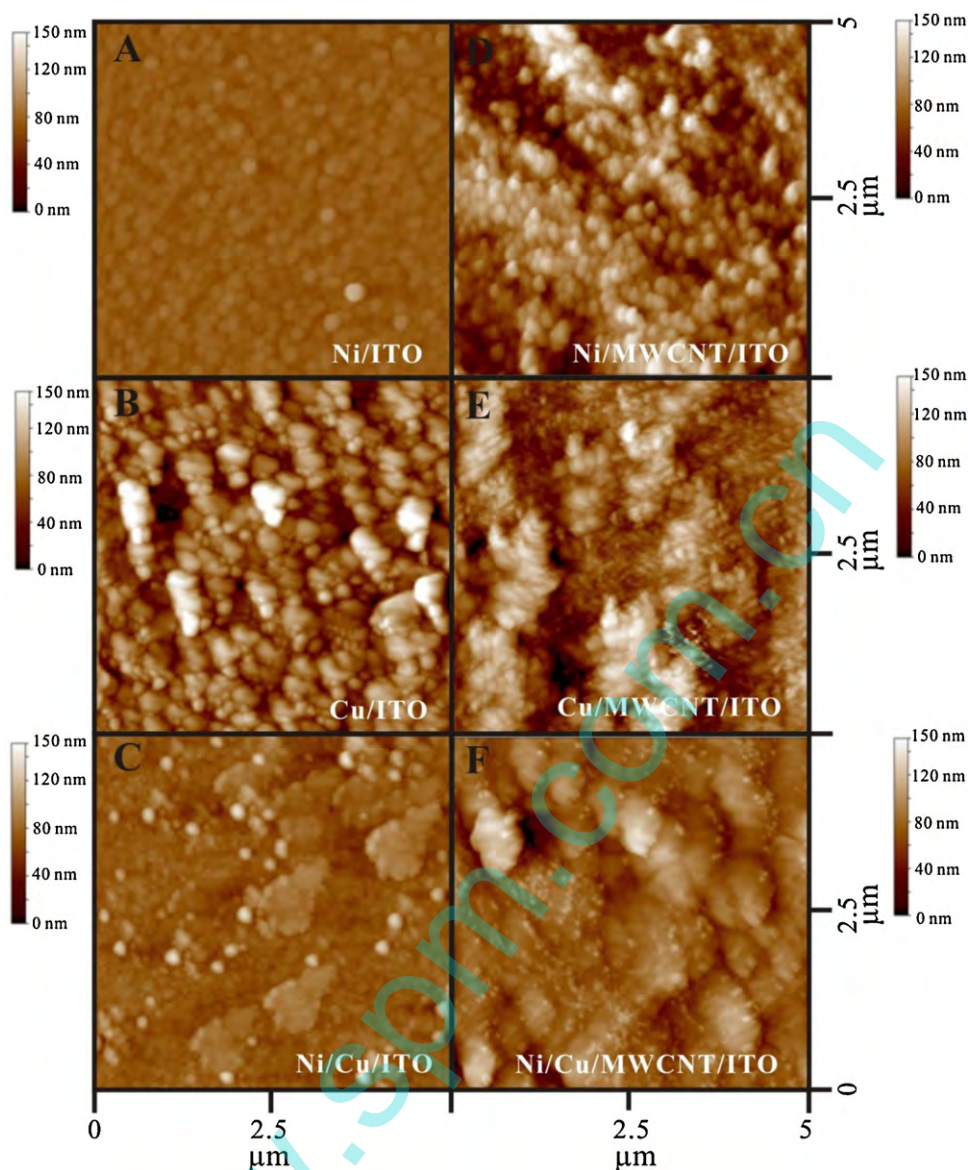

Fig. 2. AFM images of (A) Ni/ITO, (B) Cu/ITO, (C) Ni/Cu/ITO, (D) Ni/MWCNT/ITO, (E) Cu/MWCNT/ITO, and (F) Ni/Cu/MWCNT/ITO. Tapping mode, scan scale = 2000 nm × 2000 nm.

nucleation of NiO(OH) and the subsequent increase in the prevalence of activation sites (Ni^{2+} or Ni^{3+}).



Fig. 3B displays the pH-dependent voltammetric response of the Ni/Cu/MWCNT modified electrode obtained in solutions with pH values ranging from 9 to 13. As seen in Fig. 3B, only one redox couple is observed for the Ni/Cu/MWCNT hybrid composite, and it is similar to that of single Ni composite. This finding indicates that the deposited Cu species exhibit no obvious redox couple under these pH conditions. Furthermore, the formal potential ($E^{\circ'}$) is pH dependent and shifts negatively with the increase in pH value. The peak current is much higher than that under acidic solutions, indicating that the film is stable in the pH range of 9–13. The inset of Fig. 3B shows the formal potential of Ni/Cu/MWCNT plotted over a pH range of 9–13. The plot has a slope of -87.1 mV pH^{-1} , which is close to that predicted by the Nernst equation. In this case, a Ni(III)/(II) redox process involving a single electron transfer is proposed for this electrochemical system.

3.2. Electrocatalysis of glucose at the Ni/Cu/MWCNT electrode

To explore the analytical applicability of the metal-MWCNT hybrid composites, the electrocatalytic activity of the different composite modified electrodes towards glucose oxidation was investigated by cyclic voltammetry. All cyclic voltammograms were obtained for the modified electrodes in deoxygenated NaOH solution.

Fig. 4 displays the cyclic voltammograms of glucose oxidation at the various modified electrodes: (A) Ni/GCE, (B) Cu/GCE, (C) Ni/Cu/GCE, (D) Ni/MWCNT/GCE, (E) Cu/MWCNT/GCE, and (F) Ni/Cu/MWCNT/GCE. Curve (a') shows the voltammogram of the bare electrode examined in the presence of $3 \times 10^{-4} \text{ M}$ glucose, as shown in Fig. 4A–F. The Ni/GCE, Cu/GCE, Ni/Cu/GCE, Ni/MWCNT/GCE, Cu/MWCNT/GCE, and Ni/Cu/MWCNT/GCE modified electrodes show an obvious oxidation peak at +0.54 V, +0.56 V, +0.50 V, +0.63 V, +0.48 V, and +0.575 V, respectively. The oxidation potentials may correspond to a redox couple for Ni(II)/Ni(III) [37–40] and Cu(II)/Cu(III) [27,33,41,42]. These results are in good agreement with previous works. As indicated in the literature, the oxidation of glucose to gluconolactone was catalysed by the

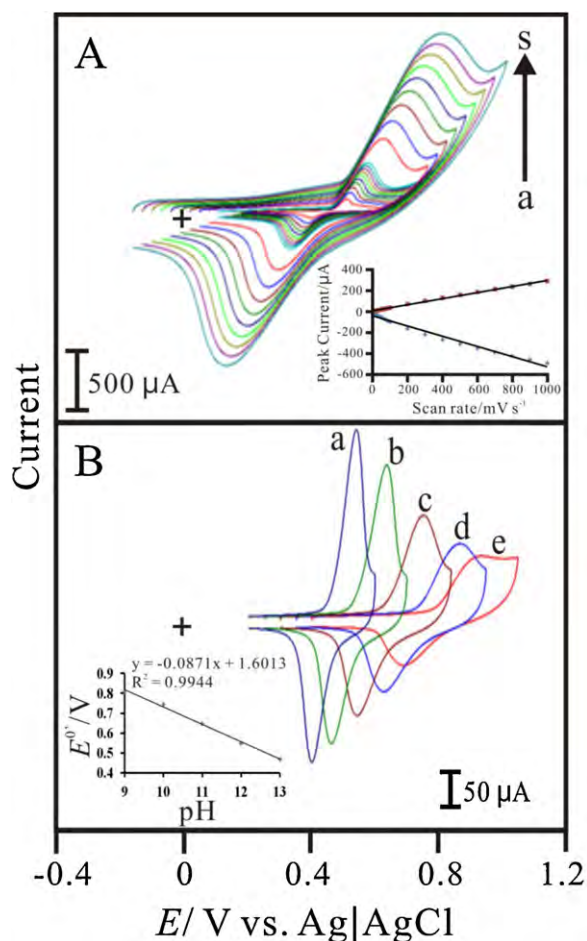
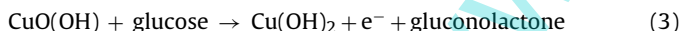
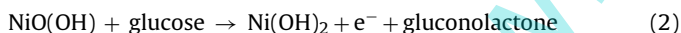

Fig. 3. Cyclic voltammograms of Ni/Cu/MWCNT/GCE examined (A) at various scan rates (ν =(a) 10 mV s^{-1} – (s) 1000 mV s^{-1} , pH 13) and (B) under different pH conditions (pH=(a) 13 – (e) 9, ν =100 mV s^{-1}). Insets: plots of peak current vs. scan rate and formal potential (E°) vs. pH.

Ni(III)/Ni(II) and Cu(III)/Cu(II) redox couples according to the following reactions:



The Ni/Cu/MWCNT shows a lower oxidation peak (approximately +0.45 V) for glucose oxidation (Fig. 4F). It should be noticed that the Ni/Cu/MWCNT voltammogram (Fig. 4F) is presented using a current scale that is 10 times greater than that used in the Cu/MWCNT voltammogram (Fig. 4E). When Fig. 4E and F are shown using the same current scale, the Ni/Cu/MWCNT current response is fairly high, indicating that it is the electrocatalytic oxidation current response (at approximately +0.45 V) contributed by Cu/MWCNT species. This oxidation peak potential is slightly lower than that of the oxidation peak in Fig. 4E. Ni/Cu/MWCNT has two oxidation peaks ($E_{\text{pa}} = +0.575$ V and +0.45 V), which are strongly related to the oxidation peaks of Ni(II)/Ni(III) and Cu(II)/Cu(III). This finding indicates that the hybrid composite maintains the catalytic activity of Ni and Cu species. In the presence of 3×10^{-4} M glucose, the Ni/GCE, Cu/GCE, Ni/Cu/GCE, Ni/MWCNT/GCE, Cu/MWCNT/GCE, and Ni/Cu/MWCNT/GCE modified electrodes had net currents of 10 μA , 20 μA , 5 μA , 40 μA , 25 μA , and 100 μA , respectively. All metal-MWCNT composites show current responses that are approximately 4, 1.25, and 20 times greater than those in MWCNT-free metal species. This phenomenon indicates that the higher current response is partially due to the high conductivity of the

Table 1

Net current and net charge contribution for glucose oxidation using Ni/Cu/MWCNT hybrid composites with different Cu:Ni ratios.

Cu:Ni ^a	ΔI^b (μA)	ΔQ^c (μC)
20:100	77.7	50.7
40:80	82.9	50
60:60	122.7	90.8
80:40	65.5	74.59
100:20	48.44	10.56

^a The ratio of scan segments for the voltammetric electro-deposition of copper and nickel.

^b The net current estimated at the anodic peak of $E_{\text{pa}} = +0.575$ V in the absence/presence of 300 μM glucose.

^c The net charge estimated in the absence/presence of 300 μM glucose.

MWCNTs. The MWCNT-based modified electrode provides more steric structure and a more conductive surface area to carry Ni and Cu active species. Moreover, the Ni/Cu/MWCNT shows a uniquely high net current that is approximately 2.5–20 times greater than those in other modified electrodes. The current responses for Ni/Cu and Ni/Cu/MWCNT are not the sum of those for the single species. The lower current response of the Ni/Cu composite may be due to the shielding effect of the layer-by-layer stacking composite. In the Ni and Cu electro-deposition processes, Ni ions and Cu ions might compete with one another to deposit on the electrode surface and occupy the effective area, resulting in a disordered structure and less deposition. The much higher current response of the Ni/Cu/MWCNT electrode may be due to its uniform and compact structure (Scheme 1). This well-dispersed functionalised MWCNT can provide a more conductive surface area to separately load Ni and Cu active species on the electrode surface, resulting in a uniform, compact, and active hybrid composite. Thus, this hybrid composite can show specific activity towards glucose oxidation. The Ni/Cu/MWCNT composite likely has good electroactivity for glucose oxidation due to its low over-potential and high current response. This finding suggests that the Ni/Cu/MWCNT composite exhibits high electrocatalytic activity in the direct oxidation of glucose.

The Cu/Ni ratio is a key parameter in the preparation of an active hybrid composite. This ratio is related to the amounts of Cu and Ni electro-deposited and can be controlled by different segments. All designed composites were prepared well, as indicated by the good current development shown in the voltammograms, and deposition occurred normally in every procedure. When these composites were examined for the electrocatalytic oxidation of glucose, all of them exhibited almost identical oxidation peaks regardless of current response. The net current (ΔI) and net charge (ΔQ) were estimated for the electrocatalytic activity towards glucose oxidation by different composites. As shown in Table 1, ΔI and ΔQ were estimated using the anodic peak current at $E_{\text{pa}} = +0.575$ V in the absence/presence of 300 μM glucose. The highest values of ΔI and ΔQ are found for a ratio of 60:60, suggesting that this composite exhibits high activity towards glucose oxidation. This result also indicates that this ratio is the optimised condition for the preparation of an active Ni/Cu/MWCNT composite. The increase in surface area is estimated as 0.169 cm^2 according to a previous method [43]. This increase in the surface area directly contributes to the electrocatalytic performance for glucose oxidation.

The solution pH is also an important factor in determining the activity of nonenzymatic glucose sensors towards glucose oxidation. Fig. 5 shows the cyclic voltammograms of Ni/Cu/MWCNT/GCE examined at various pH values in the absence/presence of 1×10^{-4} M glucose. The anodic peak current (I_{pa}) increases obviously with increasing pH. The anodic current change (ΔI_{pa}) was the result estimated by the I_{pa} value in the absence/presence of 1×10^{-4} M glucose. The ΔI_{pa} value also increases with increasing pH. A

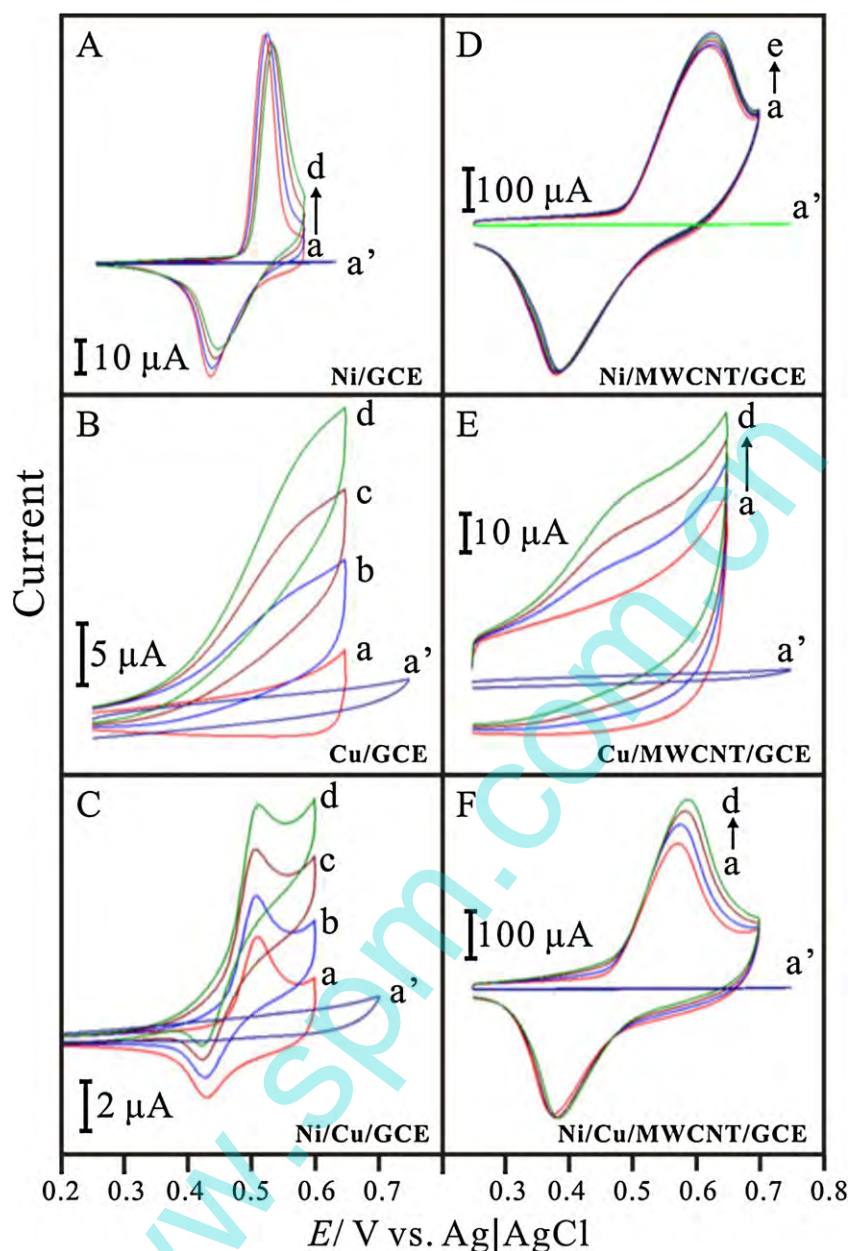

Fig. 4. Cyclic voltammograms of (A) Ni/GCE, (B) Cu/GCE, (C) Ni/Cu/GCE, (D) Ni/MWCNT/GCE, (E) Cu/MWCNT/GCE, and (F) Ni/Cu/MWCNT/GCE examined in 0.1 M NaOH (pH 13) containing [glucose] = (a) 0 M, (b) 1×10^{-4} M, (c) 2×10^{-4} M, and (d) 3×10^{-4} M, respectively. (a') is a cyclic voltammogram of bare GCE examined in the presence of 3×10^{-4} M glucose. Scan rate = 0.1 V s^{-1} .

high ΔI_{pa} value is found for pH 13 (inset of Fig. 5), suggesting this value as the optimised pH condition for glucose oxidation. The Ni/Cu/MWCNT composite shows a higher oxidation current response to glucose under high-pH conditions. Thus, the hybrid composite is better able to perform the electrocatalytic oxidation of glucose in the hydroxide-rich solution.

3.3. Amperometric response of the Ni/Cu/MWCNT electrode to glucose

Because two oxidation peaks are observed at +0.575 V and +0.45 V in the voltammogram, either can be selected as the working potential for the amperometric determination of glucose oxidation using the Ni/Cu/MWCNT electrode. In this work, the amperograms were obtained at $E_{app.} = +0.575 \text{ V}$ due to the much higher current response at this voltage, which provides the well-defined, stable,

and fast (response time = 1 s) amperometric response shown in Fig. 6.

Fig. 6A shows the amperometric response of the Ni/Cu/MWCNT electrode examined with several additions of $25 \mu\text{M}$ glucose (once every 50 s) spiked into 0.1 M NaOH solution. The response curve turns downward with increasing concentration because an increasing amount of intermediate species is adsorbed onto the electrode surface, prolonging the reaction time. The calibration curve for the glucose sensor is shown in the inset of Fig. 6A, which provides the regression equation, $I_{pa}(\mu\text{A}) = -744596c_{\text{glucose}}(\mu\text{M}) + 29$, with correlation coefficient of $R^2 = 0.995$. The electrode has a linear concentration range of 2.5×10^{-8} – 8×10^{-4} M, a sensitivity of $2633 \mu\text{A mM}^{-1} \text{ cm}^{-2}$, and a detection limit of $0.025 \mu\text{M}$ (2.5×10^{-8} M) (signal/noise = 3). Considering that the concentration threshold of glucose is 4.4–6.1 mM (79.2–109.8 mg dL⁻¹) [44], it is further examined at higher concentrations in the

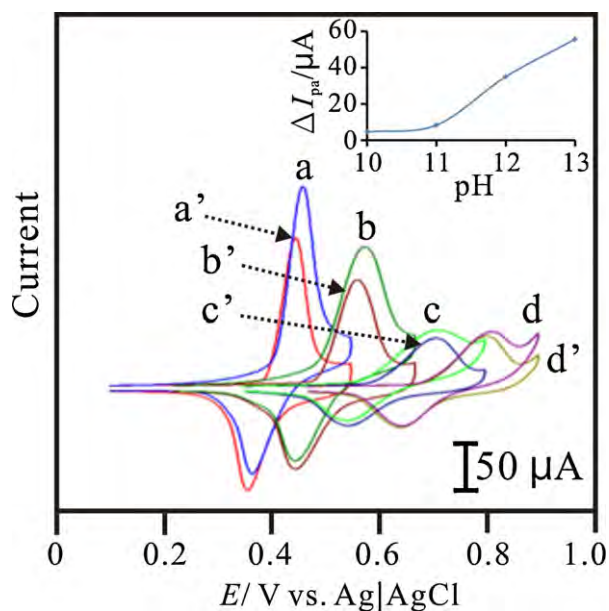

Fig. 5. Cyclic voltammograms of Ni/Cu/MWCNT/GCE examined in the presence of 1×10^{-4} M glucose at (a) pH 13, (b) pH 12, (c) pH 11, and (d) pH 10, respectively. Curve (a')–(d') are the cyclic voltammograms of Ni/Cu/MWCNT/GCE examined in the absence of glucose at (a') pH 13, (b') pH 12, (c') pH 11, and (d') pH 10, respectively. Scan rate = 0.1 V s^{-1} . Inset: plot of the anodic peak current change (ΔI_{pa}) vs. pH.

range of 1×10^{-3} – 9×10^{-3} M. The electrode provides a linear concentration range of 2×10^{-3} – 8×10^{-3} M and a sensitivity of $2437 \mu\text{A mM}^{-1} \text{ cm}^{-2}$ (Fig. 6B). Thus, the Ni/Cu/MWCNT electrode can operate well in normal blood glucose levels with good sensitivity. The two linear concentration ranges correspond to high and low ranges. Repeated testing yielded the same result. We attribute this phenomenon to the sensor nature; due to the variation in its glucose concentration tolerance, the sensor has a better ability to determine glucose with higher sensitivity and over a broader range at low concentrations ($<1 \text{ mM}$ glucose). Although the sensor shows relative low sensitivity, it is still competitive over the concentration threshold of glucose relative to other sensors in the literature. Based on these results, the Ni/Cu/MWCNT electrode is appropriate for human blood glucose levels.

Various nonenzymatic glucose sensors are summarised in Table 2. The Ni/Cu/MWCNT modified electrode shows superior sensitivity to those using SWCNTs, MWCNTs, and other materials, such as noble metals and NPs. When compared to Cu/MWCNT and Ni/MWCNT electrodes, it is clear that this good performance is due to the Ni and Cu NPs decorating the MWCNTs on the electrode surface, which significantly increases the number of electrocatalytic active areas and promotes electron transfer in the oxidation of glucose. The Ni/Cu/MWCNT nanocomposite based electrochemical sensor exhibits high sensitivity, a low detection limit, and a broad linear concentration range.

3.4. Reproducibility, stability, and anti-interference property of the Ni/Cu/MWCNT electrode

The reproducibility and stability of the sensor were evaluated. Five Ni/Cu/MWCNT electrodes were investigated by amperometry ($E_{app} = +0.575 \text{ V}$). The amperometric responses of the Ni/Cu/MWCNT/GCE were obtained in 0.1 M NaOH (pH 13) with sequential additions of 1 mM glucose. The relative standard deviation (RSD) was 1.77%, confirming the high reproducibility of the preparation method. Ten successive measurements of glucose on one Ni/Cu/MWCNT electrode yielded an RSD of 3.8%, indicating that the sensor was stable. The long-term stability of the sensor was

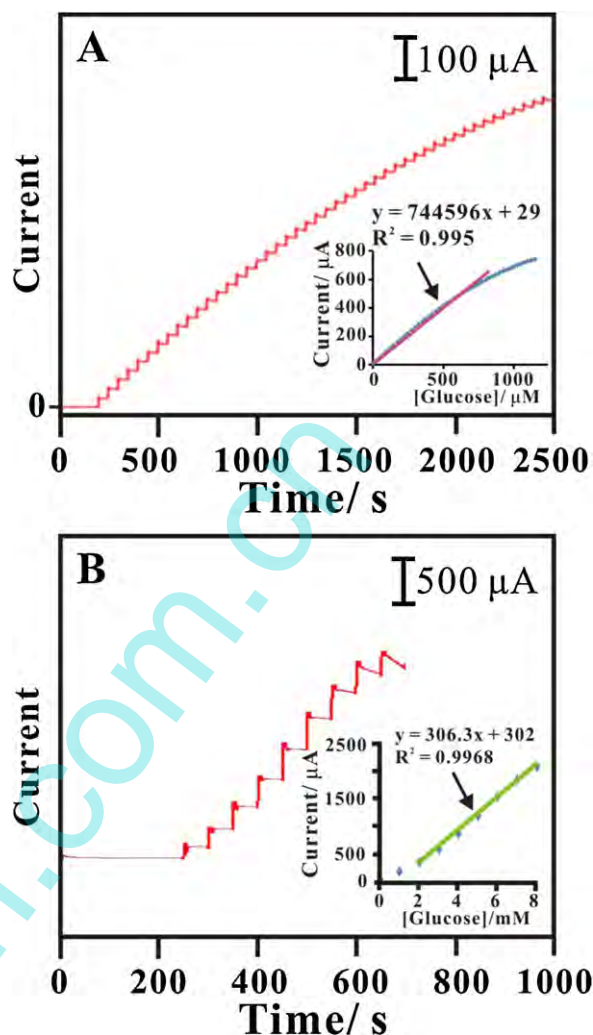

Fig. 6. Amperometric response of Ni/Cu/MWCNT/GCE examined in 0.1 M NaOH (pH 13) with sequential additions of glucose at (A) low concentration ($25 \mu\text{M}$ – 1.15 mM) and (B) high concentration (1 – 9 mM). Insets: plots of the anodic peak current response (I_{pa}) vs. glucose concentration. Electrode rotation rate = 2000 rpm . $E_{app} = +0.575 \text{ V}$.

also evaluated by measuring its current response to glucose within a 30-day period. The sensor was exposed to air, and its sensitivity was tested every 3 days. The current response of the Ni/Cu/MWCNT electrode was approximately 90% of its original counterpart, which can be mainly attributed to the chemical stability of Ni and Cu in basic solution. The current response of the Ni/Cu/MWCNT electrode was also examined by adding 1 M KCl to the solution as a supporting electrolyte. Based on this result, the Ni/Cu/MWCNT electrode shows a nearly constant peak current towards glucose oxidation, indicating that the electrode is not poisoned by chloride ions.

Anti-interference studies are also important and necessary for sensors. Some easily oxidative species, such as ascorbic acid (AA), dopamine (DA), and uric acid (UA), usually co-exist with glucose in human blood. Thus, the electrochemical response of the interfering species was also examined at the Ni/Cu/MWCNT electrode. Considering that the glucose concentration in human blood is at least 30 times greater than that of interfering species, the interference experiment was carried out by the successive injection of glucose and interfering species in 0.1 M NaOH solution. The amperometric response of Ni/Cu/MWCNT/GCE was examined in 0.1 M NaOH (pH 13) with sequential additions of $10 \mu\text{M}$ glucose with $1 \mu\text{M}$ interferents (DA, AA, and UA). A well-defined glucose response was

Table 2

Performance comparison of the Ni/Cu/MWCNT electrode and other nonenzymatic glucose sensors.

Electrode	Detection potential (V)	Sensitivity ($\mu\text{A mM}^{-1} \text{cm}^{-2}$)	Linear range (M)	Detection limit (μM)	Reference
Porous Au	0.35	11.8	2×10^{-3} – 1×10^{-2}	5	[4]
MnO ₂ /MWCNT	0.3	33.2 $\mu\text{A mM}^{-1}$	1×10^{-5} – 2.8×10^{-2}	–	[11]
CuO nanowires	0.33	0.5	4×10^{-7} – 2×10^{-3}	0.049	[12]
Mesoporous Pt	0.4	9.6	0 – 1×10^{-2}	–	[19]
MWCNT	0.2	4.4	2×10^{-6} – 1.1×10^{-2}	1	[21]
Cu nanoparticles	0.65	–	1×10^{-6} – 5×10^{-3}	0.5	[27]
Ni nanowires	0.55	1043	5×10^{-7} – 7×10^{-3}	0.1	[37]
Cu/MWCNT	0.65	251.4	7×10^{-4} – 3.5×10^{-3}	0.21	[33]
Freestanding SWCNT film	0.6	248.6	1×10^{-5} – 2.16×10^{-3}	10	[45]
Pt nanotubes	0.4	0.1	2×10^{-3} – 1.4×10^{-2}	1	[46]
Pt–Pb/CNTs	0.3	17.8	Up– 1.1×10^{-2}	1.8	[47]
Au nanoparticles	–	160	5×10^{-4} – 8×10^{-3}	–	[48]
CuO/MWCNT	0.4	2596	4×10^{-7} – 1.2×10^{-3}	0.2	[49]
Ni–MWCNT	0.6	67.19	3.2×10^{-6} – 1.75×10^{-2}	0.89	[50]
Ni/Cu/MWCNT	0.575	2633	2.5×10^{-8} – 8×10^{-4}	0.025	This work
	0.575	2437	2×10^{-3} – 8×10^{-3}	0.025	

Table 3

Amperometric glucose sensor applied to human blood serum samples.

Sample	Concentration (mM)	RSD ^a (%)	Added (mM)	Recovery (%)
1	11.7	1.2	0.1	100.60
2	7.8	2.3	0.1	98.97
3	4.3	1.8	0.1	99.21

^a RSD (%) calculated from three separate experiments.

obtained, and insignificant responses were observed for interfering species. Compared to glucose, the interfering species yielded current response ranging from 1.7% (uric acid) to 8.6% (dopamine) at +0.575 V. These small responses for DA, AA, and UA can be neglected. In other words, the Ni/Cu/MWCNT electrode shows good selectivity for glucose detection.

3.5. Human serum samples measurement

In an attempt to assess the feasibility of using the Ni/Cu/MWCNT electrode for practical applications, the sensor was applied to determine glucose in human blood serum samples from diabetic and healthy people. At an applied potential of +0.575 V, 25 μL of the serum sample was added to 10 mL of 0.1 M NaOH solution and the current response was recorded. The recovery of glucose was determined by the standard addition of pure glucose to the solutions containing the serum samples, and the corresponding results were presented in Table 3. The Ni/Cu/MWCNT sensor showed exact recovery ($\geq 95\%$). The results demonstrated herein support the potential application of the Ni/Cu/MWCNT sensor for the determination of glucose in biological fluids.

4. Conclusions

We have successfully deposited Ni and Cu nanoparticles on the MWCNT modified electrode by cyclic voltammetry. The Ni/Cu/MWCNT electrode, a novel nonenzymatic glucose sensor, presents attractive analytical features, such as high sensitivity, strong stability, good reproducibility, and selectivity as well as short response times. The Ni/Cu/MWCNT electrode can also be used as an amperometric sensor for the routine analysis of glucose in human serum samples. Based on the nonenzymatic glucose determination literature, it is competitive for the effective determination of glucose with low cost, low over-potential, a low detection limit, and high sensitivity.

Acknowledgment

We acknowledge the National Science Council (project no. NSC982113M027006MY3), Taiwan.

References

- [1] J. Wang, *Electrochemical glucose biosensors*, Chemical Reviews 108 (2008) 814.
- [2] B. Sljukic, C.E. Banks, C. Salter, A. Crossley, R.G. Compton, Electrochemically polymerised composites of multi-walled carbon nanotubes and poly(vinylferrocene) and their use as modified electrodes: Application to glucose sensing, *Analyst* 131 (2006) 670.
- [3] Y.B. Vassilyev, O.A. Khazova, N.N. Nikolaeva, Kinetics and mechanism of glucose electrooxidation on different electrode-catalysts. Part I. Adsorption and oxidation on platinum, *Journal of Electroanalytical Chemistry* 196 (1985) 105.
- [4] Y. Li, Y.Y. Song, C. Yang, X.H. Xia, Hydrogen bubble dynamic template synthesis of porous gold for nonenzymatic electrochemical detection of glucose, *Electrochemistry Communications* 9 (2007) 981.
- [5] P. Luo, F. Zhang, R.P. Baldwin, Comparison of metallic electrodes for constant-potential amperometric detection of carbohydrates, amino acids and related compounds in flow systems, *Analytica Chimica Acta* 244 (1991) 169.
- [6] M. Sakamoto, K. Takamura, Catalytic oxidation of biological components on platinum electrodes modified by adsorbed metals: anodic oxidation of glucose, *Bioelectrochemistry and Bioenergetics* 9 (1982) 571.
- [7] Y. Sun, H. Buck, T.E. Mallouk, Combinatorial discovery of alloy electrocatalysts for amperometric glucose sensors, *Analytical Chemistry* 73 (2001) 1599.
- [8] S.B. Aoun, G.S. Bang, T. Koga, Y. Nonaka, T. Sotomura, I. Taniguchi, Electro-catalytic oxidation of sugars on silver-UPD single crystal gold electrodes in alkaline solutions, *Electrochemistry Communications* 5 (2003) 317.
- [9] S.B. Aoun, Z. Dursun, T. Koga, G.S. Bang, T. Sotomura, I. Taniguchi, Effect of metal ad-layers on Au(111) electrodes on electrocatalytic oxidation of glucose in an alkaline solution, *Journal of Electroanalytical Chemistry* 567 (2004) 175.
- [10] E.A. Irhayem, H. Elzanowska, A.S. Jhas, B. Skrzynecka, V. Birss, Glucose detection based on electrochemically formed Ir oxide films, *Journal of Electroanalytical Chemistry* 538–539 (2002) 153.
- [11] J. Chen, W.D. Zhang, J.S. Ye, Nonenzymatic electrochemical glucose sensor based on MnO₂/MWCNTs nanocomposite, *Electrochemistry Communications* 10 (2008) 1268.
- [12] Z.J. Zhuang, X.D. Su, H.Y. Yuan, Q. Sun, D. Xiao, M.M.F. Choi, An improved sensitivity non-enzymatic glucose sensor based on a CuO nanowire modified Cu electrode, *Analyst* 133 (2008) 126.
- [13] H.T. Zhao, H.X. Ju, Multilayer membranes for glucose biosensing vialayer-by-layer assembly of multiwall carbon nanotubes and glucoseoxidase, *Analytical Biochemistry* 350 (2006) 138.
- [14] A. Merkoci, M. Pumera, X. Llopis, B. Perez, M. del-Valle, S. Alegret, New materials for electrochemical sensing VI: carbon nanotubes, *Trends in Analytical Chemistry* 24 (2005) 826.
- [15] V.G. Gavalas, S.A. Law, J.C. Ball, R. Andrews, L.G. Bachas, Carbon nanotube aqueous sol-gel composites: enzyme-friendly platforms for the development of stable biosensors, *Analytical Biochemistry* 329 (2004) 247.
- [16] Y. Lin, X. Cui, X. Ye, Electrocatalytic reactivity for oxygen reduction of palladium-modified carbon nanotubes synthesized in supercritical fluid, *Electrochemistry Communications* 7 (2005) 267.
- [17] M.L. Mena, P.Y. Yanez-Sedeno, J.M. Pingarro, A comparison of different strategies for the construction of amperometric enzyme biosensors using gold nanoparticle-modified electrodes, *Analytical Biochemistry* 336 (2005) 20.
- [18] C.M. Welch, R.G. Compton, The use of nanoparticles in electroanalysis: a review, *Analytical and Bioanalytical Chemistry* 384 (2006) 601.

- [19] S. Park, T.D. Chung, H.C. Kim, Nonenzymatic glucose detection using mesoporous platinum, *Analytical Chemistry* 75 (2003) 3046.
- [20] H. Boo, S. Park, B. Ku, Y. Kim, J.H. Park, H.C. Kim, T.D. Chung, Ionic strength-controlled virtual area of mesoporous platinum electrode, *Journal of the American Chemical Society* 126 (2004) 4524.
- [21] J.S. Ye, Y. Wen, W.D. Zhang, L.M. Gan, G.Q. Xu, F.S. Sheu, Nonenzymatic glucose detection using multi-walled carbon nanotube electrodes, *Electrochemistry Communications* 6 (2004) 66.
- [22] R.P. Deo, J. Wang, Electrochemical detection of carbohydrates at carbon-nanotube modified glassy-carbon electrodes, *Electrochemistry Communications* 6 (2004) 284.
- [23] T. You, O. Niwa, Z. Chen, K. Hayashi, M. Tomita, S. Hirono, An amperometric detector formed of highly dispersed Ni nanoparticles embedded in a graphite-like carbon film electrode for sugar determination, *Analytical Chemistry* 75 (2003) 5191.
- [24] M. Tominaga, T. Shimazoe, M. Nagashima, I. Taniguchi, Electrocatalytic oxidation of glucose at gold nanoparticle-modified carbon electrodes in alkaline and neutral solutions, *Electrochemistry Communications* 7 (2005) 189.
- [25] M. Tominaga, T. Shimazoe, M. Nagashima, H. Kusuda, A. Kubo, Y. Kuwahara, I. Taniguchi, Electrocatalytic oxidation of glucose at gold–silver alloy, silver and gold nanoparticles in an alkaline solution, *Journal of Electroanalytical Chemistry* 590 (2006) 37.
- [26] I.G. Casella, M. Gatta, M.R. Guascito, T.R.I. Cataldi, Highly-dispersed copper microparticles on the active gold substrate as an amperometric sensor for glucose, *Analytica Chimica Acta* 357 (1997) 63.
- [27] Q. Xu, Y. Zhao, J.Z. Xu, J.J. Zhu, Preparation of functionalized copper nanoparticles and fabrication of a glucose sensor, *Sensors and Actuators B* 114 (2006) 379.
- [28] K.B. Male, S. Hrapovic, Y. Liu, D. Wang, J.H.T. Luong, Electrochemical detection of carbohydrates using copper nanoparticles and carbon nanotubes, *Analytica Chimica Acta* 516 (2004) 35.
- [29] J. Wang, G. Chen, M. Wang, M.P. Chatrathi, Carbon-nanotube/copper composite electrodes for capillary electrophoresis microchip detection of carbohydrates, *Analyst* 129 (2004) 512.
- [30] K.C. Lin, T.H. Tsai, S.M. Chen, Performing enzyme-free H_2O_2 biosensor and simultaneous determination for AA, DA, and UA by MWCNT–PEDOT film, *Biosensors and Bioelectronics* 26 (2010) 608.
- [31] S. Arai, M. Endo, N. Kaneko, Ni-deposited multi-walled carbon nanotubes by electrodeposition, *Carbon* 42 (2004) 641.
- [32] S. Arai, M. Endo, Carbon nanofiber–copper composite powder prepared by electrodeposition, *Electrochemistry Communications* 5 (2003) 797.
- [33] X.H. Kang, Z.B. Mai, X.Y. Zou, P.X. Cai, J.Y. Mo, A sensitive nonenzymatic glucose sensor in alkaline media with a copper nanocluster/multiwall carbon nanotube-modified glassy carbon electrode, *Analytical Biochemistry* 363 (2007) 143.
- [34] S.H. Wu, D.H. Chen, Synthesis of high-concentration Cu nanoparticles in aqueous CTAB solutions, *Journal of Colloid and Interface Science* 273 (2004) 165.
- [35] W. Xu, K.Y. Liew, H. Liu, T. Huang, C. Sun, Y. Zhao, Microwave-assisted synthesis of nickel nanoparticles, *Materials Letters* 62 (2008) 2571.
- [36] A.S. Adekunle, K.I. Ozoemena, Electron transport and electrocatalytic properties of MWCNT/nickel nanocomposites: hydrazine and diethylaminoethanethiol as analytical probes, *Journal of Electroanalytical Chemistry* 645 (2010) 41.
- [37] L.M. Lu, L. Zhang, F.L. Qu, H.X. Lua, X.B. Zhang, Z.S. Wu, S.Y. Huan, Q.A. Wang, G.L. Shen, R.Q. Yu, A nano-Ni based ultrasensitive nonenzymatic electrochemical sensor for glucose: enhancing sensitivity through a nanowire array strategy, *Biosensors and Bioelectronics* 25 (2009) 218.
- [38] A. Salimi, M. Roushani, Non-enzymatic glucose detection free of ascorbic acid interference using nickel powder and nafion sol–gel dispersed renewable carbon ceramic electrode, *Electrochemistry Communications* 7 (2005) 879.
- [39] H. Ai, X. Huang, Z. Zhu, J. Liu, Q. Chi, Y. Li, Z. Li, X. Ji, A novel glucose sensor based on monodispersed Ni/Al layered double hydroxide and chitosan, *Biosensors and Bioelectronics* 24 (2008) 1048.
- [40] Y. Wang, Y. Xu, L. Luo, Y. Ding, X. Liu, A. Huang, A novel sensitive nonenzymatic glucose sensor based on perovskite $LaNi_{0.5}Ti_{0.5}O_3$ -modified carbon paste electrode, *Sensors and Actuators B* 151 (2010) 65.
- [41] X. Li, Q. Zhu, S. Tong, W. Song, Self-assembled microstructure of carbon nanotubes for enzymeless glucose sensor, *Sensors and Actuators B* 136 (2009) 444.
- [42] H.X. Wu, W.M. Cao, Y. Li, G. Liu, Y. Wen, H.F. Yang, S.P. Yang, In situ growth of copper nanoparticles on multiwalled carbon nanotubes and their application as non-enzymatic glucose sensor materials, *Electrochimica Acta* 55 (2010) 3734.
- [43] S. Zheng, Y. Huang, G. Chen, Electrochemical behavior of *o*-sec-butylphenol at glassy carbon electrode modified with multiwalled carbon nanotubes and 1-butyl-3-methylimidazolium hexafluorophosphate, *Analyst* 137 (2012) 4335.
- [44] R. Hu, A.C. Stevenson, C.R. Lowe, An acoustic glucose sensor, *Biosensors and Bioelectronics* 35 (2012) 425.
- [45] J.X. Wang, X.W. Sun, X.P. Cai, Y. Lei, L. Song, S.S. Xie, Nonenzymatic glucose sensor using freestanding single-wall carbon nanotube films, *Electrochemical and Solid-State Letters* 10 (2007) J58.
- [46] J.H. Yuan, K. Wang, X.H. Xia, Highly ordered platinum–nanotubule arrays for amperometric glucose sensing, *Advanced Functional Materials* 15 (2005) 803.
- [47] H.F. Cui, J.S. Ye, W.D. Zhang, C.M. Li, J.H.T. Luong, F.S. Sheu, Selective and sensitive electrochemical detection of glucose in neutral solution using platinum–lead alloy nanoparticle/carbon nanotube nanocomposites, *Analytica Chimica Acta* 594 (2007) 175.
- [48] F. Kurniawan, V. Tsakova, V.M. Mirsky, Gold nanoparticles in nonenzymatic electrochemical detection of sugars, *Electroanalysis* 18 (2006) 1937.
- [49] L.C. Jiang, W.D. Zhang, A highly sensitive nonenzymatic glucose sensor based on CuO nanoparticles-modified carbon nanotube electrode, *Electroanalysis* 21 (2009) 988.
- [50] A. Sun, J. Zheng, Q. Sheng, A highly sensitive non-enzymatic glucose sensor based on nickel and multi-walled carbon nanotubes nanohybrid films fabricated by one-step co-electrodeposition in ionic liquids, *Electrochimica Acta* 65 (2012) 64.